













1	008L AB стопр #120
2	008L AC стопр #120
3	008L PB стопр #120
4	008L SS стопр #120
5	008M AB стопр #180
6	008M AC стопр #180
7	008M PB стопр #180



8	008M SS стопр #180	
9	020 AB стопр #200	
10	020 AC стопр #200	
11	020 PB стопр #200	
12	020 SS стопр #200	
13	030-128 AB #480	
14	030-128 AC #480	
15	030-128 CP #480	
16	030-128 WW #480	
17	030-160 AB #360	
18	030-160 AC #360	
19	030-160 CP #360	

20	030-160 PB #360
21	030-160 WW #360
22	041 AB #100
23	041 AC #100
24	041 PB #100
25	041 PCF #100
26	041 SN #100
27	043 AB #100



28	043 AC #100
29	043 PB #100
30	043 PCF #100
31	043 SN #100
32	08-287 AB замок #20
33	08-287 AC замок #20
34	08-287 KBN\GP замок #20



35	08-287 KSG\GP замок #20	
36	08-287 MCF замок #20	
37	090 AB Зубер завертка #200	
38	090 AC Зубер завертка #200	
39	090 CF Зубер завертка #200	
40	090 PB Зубер завертка #200	
41	090 SS Зубер завертка #200	
42	09-287 AB замок #20	

43	09-287 AC замок #20	
44	09-287 KBN\GP замок #20	
45	09-287 KSG/GP замок #20	
46	09-287 MCF замок #20	
47	1,25мм # Мебельные Колеса Черные #1000	
48	1,5мм Ролик черный #250	
49	1.5 # Мебельные Колеса Белые #500	
50	1070-4М #25	
51	1082-3М Титан замок #30	









52	12 V Электро-механ замок 1-L #12
53	12 V Электро-механ замок 1-R #12
54	12 V Электро-механ замок 2-L #12
55	12 V Электро-механ замок 2-R #12
56	12 V Электро-механ замок 3-L #12
57	12 V Электро-механ замок 3-R #12
58	1201 Иранский шпингалет большой #384
59	1201 Иранский шпингалет маленький #480
60	1285-3M #20
61	1351-3M #40
62	1378-3M #25













63	1423 AB #16
64	1423 CP #16
65	155 Ролик #50
66	1601 AB #16
67	1601 AC #16
68	1601 CP #16
69	1623 AB #16

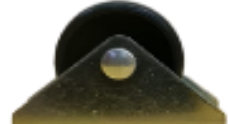



70	1623 AC #16	
71	1623 CP #16	
72	1801* #200	
73	1802* #200	
74	1803* #200	
75	1804* #200	
76	1805* #200	
77	1806* #200	

78	1811* #100	
79	189-3 SB #30	
80	194 шпингалет СХ-001 #80	
81	1мм # Мебельные Колеса Белые #1600	
82	1мм # Мебельные Колеса Черные #1600	
83	1р.с Самолет навесы #600	
84	1р.с Самолет навесы #300	
85	2.5 ролик+торм черн #50	
86	2.5 ролик+торм черн #60	
87	2082-4M #25	
88	2203 шпингалет АВ #240	









89	2203 шпингалет АС #240
90	2203 шпингалет СР #240
91	2203 шпингалет РВ #240
92	2206 шпингалет АС #240
93	2206 шпингалет СР #240
94	2206 шпингалет РВ #240
95	230* Глазки АС #288
96	230* Глазки СР #288
97	230* Глазки РВ #288



98	2305-5 WW #24	
99	2407-07 WW #24	
100	2408-08 WW #24	
101	2415-15 WW #24	
102	2501* #200	
103	2502* #200	
104	2503* #200	
105	2504* #200	

106	2505* #200
107	2506* #200
108	2507* #200
109	2507N* #200
110	2508* #200
111	2510* #200
112	2511* #100
113	2512* #100
114	2513* #200



115	2527* #200	
116	256-CP ночник # 60	
117	256-AB ночник # 60	
118	2мм Ролик черный #150	
119	2мм Ролик черный + тормоз #120	
120	2р.с Самолет навесы #120	
121	2р.с Самолет навесы с доводчиком #100	
122	3082-3М #30	
123	330-32 АВ #12	

124	330-32 MCF #12
125	330-829 MAC #12
126	330-88 AB #12
127	330-88 AC #12
128	330-88 MCF #12
129	330-88 WW/GP #12
130	Зкл 60мм Сердцевины # 120
131	4*100 АВ Навесы универсал #50



132	4*100 AC Навесы универсал #50
133	40 мм Навесной 4кл (Синий Ключ) #120
134	40мм Навесной 4кл (Золотистый) #120
135	5*125 АВ Навесы универсал #50
136	5*2.5 АВ-R навесы съемные #50
137	5*2.5 AC-R навесы съемные #50
138	5*2.5 PB-L навесы съемные #50





139	5*2.5 PB-R навесы съемные #50
140	5*2.5 CP-L навесы съемные #50
141	503-128 Ручки скобы AC #240
142	503-128 Ручки скобы MCF #240
143	503-128 Ручки скобы WW/GP #240
144	503-160 Ручки скобы AB #180
145	503-160 Ручки скобы MCF #180



146	503-160 Ручки скобы WW/GP #180
147	5070 АВ Механизм санузел #50
148	5070 MBN Механизм санузел #50
149	5070 MCF Механизм санузел #50
150	5070 PB Механизм санузел #50
151	5070 SN Механизм санузел #50
152	50мм Навесной 4кл (Золотистый) #96



153	50мм Навесной 4кл (Синий Ключ) #96
154	514 Краб Замки #60
155	5555 HF #15
156	5555 MCF #15
157	5555F-H замок сувальдный #20
158	5666 HF #15
159	5666 MCF #15



160	58112-112 AB #24
161	58112-112 AC #24
162	58112-112 CF #24
163	5813-578 AB #24
164	5813-578 AC #24
165	5813-578 CF #24
166	5815-16 AC #24





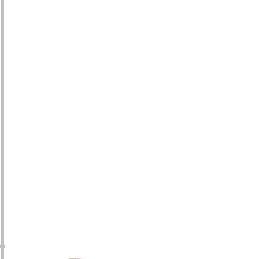



167	5815-16 CF #24
168	5817-44 AC #24
169	5817-44 CF #24
170	5818-18 AB #24
171	5818-18 AC #24
172	5818-18 BN/CP #24
173	5818-18 CF #24



174	5818-77 AB #24
175	5818-77 AC #24
176	5818-77 CF #24
177	5819-317 AC #24
178	5819-317 CF #24
179	5819-39 AB #24
180	5819-39 AC #24



181	5819-39 CF #24	
182	5835-35 AC #24	
183	5835-35 CF #24	
184	5844-26 AB #24	
185	5844-26 AC #24	
186	5844-26 BN/CP #24	
187	5844-26 CF #24	

188	5848-19 AB #24
189	5848-19 AC #24
190	5848-19 BN\GP #24
191	5848-19 MCF #24
192	5848-19 SN #24
193	5848-19 SN\GP #24
194	5878-44 AB #24





195	5878-44 AC #24
196	5878-44 CF #24
197	60 мм Навесной 4кл (Синий Ключ) #72
198	60036 А Механизм #24
199	60036 А Ручки НЕРЖАВЕЙКИ #20
200	607 AB #30
201	607 AC #30



202	607 PB #30
203	607 SS #30
204	60мм Навесной 4кл (Золотистый) #72
205	6603 Бронь замок (универсал) #12
206	6603 Бронь РУЧКА (универсал) #24
207	6605 БРОНЬ замок SS #12
208	6605 Бронь замок АС #12
209	666 шпингалет АВ #240



210	666 шпингалет АС #240	
211	666 шпингалет РВ #240	
212	666 шпингалет SN #240	
213	6кл 60мм Сердцевины # 120	
214	70 мм Навесной 4кл (Золотистый) #72	
215	70 мм Навесной 4кл (Синий Ключ) #72	
216	7004-S АВ Крючки мебельные #600	
217	7004-S РВ Крючки мебельные #600	
218	7004-S SS Крючки мебельные #600	

219	7004-S CP Крючки мебельные #600
220	7008 S AB Крючки мебельные #800
221	7008 S CP Крючки мебельные #800
222	7008 S PB Крючки мебельные #800
223	7023 AB\CP #20
224	7023 SN\CP #20
225	7096 AB\CP #20



226	7096 SN\CP #20
227	7346 AB #40
228	7346 AC #40
229	7346 GOP #40
230	74132 AC замок #16
231	74178 AB замок #16
232	74178 AC замок #16



233	74178 MCF замок #16
234	7496 GOP #40
235	7496 SN/CP #40
236	778 Механизм #30
237	8015 AB #24
238	8015 AC #24
239	8015 B #24

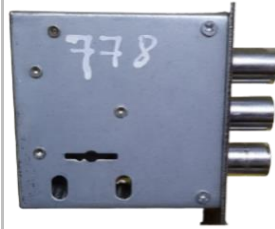

240	8015 MCF #24
241	8015 SN #24
242	8015 SN/GP #24
243	8076-807 AB #20
244	8076-807 CF #20
245	8076-807 KGP #20
246	810 Булат #50



247	813-25 АВ #20
248	813-25 АС #20
249	8203 Рамка 3-няя #300
250	8204 Рамка 4-няя #200
251	8205 Рамка 5-няя #200
252	8241-41 АВ ручки #20
253	8241-41 АС ручки #20
254	8241-41 GP ручки #20





255	8241-41 KG ручки #20
256	8241-41 MCF ручки #20
257	8241-41 WW\GP ручки #20
258	828 Механизм #20
259	83578 AB #24
260	83578 AC #24
261	83578 PCF #24



262	83578 SNCP #24
263	844-26 AB #20
264	8515-415 KGS/GP #20
265	8523 ручки (Дорогой) AB #20
266	8523 ручки AB #24
267	8523 ручки AC #24
268	8523 ручки CP #24



269	8523-49 AB #20
270	8523-49 AC #20
271	8523-49 MCF #20
272	8532-88 AB #12
273	8532-88 AC #12
274	8532-88 CF #12
275	854-24 AB #20



276	854-24 AC #20
277	854-24 CF #20
278	854-24 KSG/GP #20
279	854-24 WW\GP ручки #20
280	8549-269 AB #20
281	8549-269 AC #20
282	8549-269 CF #20



283	8549-269 KSG/GP #20
284	8550 ML AB Механизм Магнитный #50
285	8550 ML SN Механизм Магнитный #50
286	8551-413 AB #20
287	8551-413 AC #20
288	8551-413 KGP #20
289	8551-413 MCF #20



290	8551-413 WW\CP #20
291	8551-413 WW\GP #20
292	855F Самара #50
293	856-23 AB #20
294	856-23 AC #20
295	856-23 CF #20
296	856-23 SN\CP #20



297	857-578 AB #20
298	857-578 AC #20
299	857-578 MCF #20
300	858-49 AB #20
301	858-49 PCF #20
302	858-49 WWCP #20
303	858-49 WWGP #20



304	8596 ручки АВ #24	
305	8596 ручки АС #24	
306	8596 ручки СР #24	
307	86896-L CP#12	
308	86896-R CP#12	
309	871-77 АВ #20	
310	884-824 АВ #12	



311	884-824 AC #12
312	884-824 MCF #12
313	9036 CP накладка под сувальдный # 125
314	9106 AB ручки #24
315	9106 AC замок #16
316	9106 AC ручки #24
317	9106 BN/GP ручки #24



318	9106 MCF ручки #24
319	9123 AB #24
320	9123 AC #24
321	9123 MCF #24
322	9219-310 Накладной замок #30
323	9650 ML AB Механизм Магнитный #50
324	9650 ML SN Механизм Магнитный #50



325	ABASTN	висяч з-ки 38мм #240
326	ABASTN	висяч з-ки 50мм #120
327	ABASTN	висяч з-ки 63мм #60
328	ABASTN	висяч з-ки 75мм #60
329	ABASTN	Дорогой 4кл висяч з-ки 38мм #180
330	ABASTN	Дорогой 4кл висяч з-ки 50мм #120
331	ABASTN	Дорогой 4кл висяч з-ки 63мм #60



332	ABASTN Дорогой 4кл висяч з-ки 75мм #36
333	ANTIA MDF клей 200мл+65гр #24
334	APFQS 30 #144
335	APFQS 40 #120
336	APFQS 50 #120
337	APFQS 60 #72
338	APOLLO замок 6601-L #16



339	APOLLO замок 6601-L (AL сердц) #20
340	APOLLO замок 6601-R #16
341	APOLLO замок 6601-R (AL сердц) #20
342	APOLLO замок 6609-L #16
343	APOLLO замок 6609-R #16
344	APOLLO ручка 6601-L #32
345	APOLLO ручка 6601-R #32



346	APOLLO ручка 6609-L #32
347	APOLLO ручка 6609-R #32
348	APS KD 100 Сердцевины #120
349	APS KD 60 Сердцевины #120
350	APS KD 70 Сердцевины #120
351	APS KD 80 Сердцевины #120
352	APS KD 90 Сердцевины #120
353	APS KW 70 Сердцевины #120
354	APS KW 80 Сердцевины #120
355	APS KW 90 Сердцевины #120
356	APS -1- Пластик тяжелый большой #120



357	APS 156F #60
358	APS -2- Пластик тяжелый большой #120
359	APS -3- Пластик тяжелый большой #120
360	APS -4- Пластик тяжелый большой #120
361	APS -5- Пластик тяжелый большой #120
362	APS 8600 AB #40
	APS 8600 CF #40



363	APS 8600 AC #40	
364	APS 8600 SN/CP #40	
365	APS 8600 GOP #40	
366	APS*189-4 замок #30	
367	BINARY 84# Амбарный з-к #24	
368	BINARY 94# Амбарный з-к #24	
369	BK 3011-96 AB #30	
370	BK 3011-96 AC #30	



371	BK 3011-96 BN\GP #30
372	BK 3011-96 MCF #30
373	BK 3011-96 SN #30
374	BK 3011-96 SN\GP #30
375	BK 3048-07 AB #30
376	BK 3048-07 AC #30
377	BK 3048-07 BN\GP #30



378	BK 3048-07 MCF #30
379	BK 3048-07 SN #30
380	BK 3048-07 SN\GP #30
381	BK 3111-23 AB #30
382	BK 3111-23 AC #30
383	BK 3111-23 MCF #30
384	BK 3111-23 SN #30



385	BK 6123 GOP #20
386	BK 6235 AC #20
387	BK 6346 GOP #20
388	BK 6346 SN\CP #20
389	BK L55 PCF #60
390	BK L55 PVD #60
391	BK L55 WW/GP #60
392	BK L55 BRASS #60



393	BK L69 AB #60	
394	BK L69 BN/CP #60	
395	BK L69 SN/CP #60	
396	BK L69 CP #60	
397	BK L69 PVD #60	
398	BK LJ PVD #60	
399	C45 AB Язычок Безшумный #100	
400	C45 SN Язычок Безшумный #100	
401	CHEZAM большой 80мм #40	

402	CHEZAM длинный #40
403	CHEZAM квадратный 70мм #40
404	CHEZAM короткий #40
405	CK L55 WW/GP #120
406	CK L55 BRASS #120
407	CK L55 PCF #120
408	CK L55 PVD #120



409	CK L69 AB #120
410	CK L69 CP #120
411	CK L69 WW/CP #120
412	CK L69 BN/CP #120
413	CK L69 SN/CP #120
414	CK LJ PVD #120
415	CRAF AB Сердцевины KD-70 #120
416	CRAF AB Сердцевины KD-80 #120



417	CRAF AB Сердцевины KW-70 #120
418	CRAF AB Сердцевины KW-80 #120
419	CRAF 118 AB/CP #20
420	CRAF 118 SN/CP #20
421	CRAF 173 AB/CP #20
422	CRAF 173 BN/CP #20
423	CRAF 173 SN/CP #20
424	CRAF 176 AB/CP #20
425	CRAF 176 BN/CP #20



426	CRAF 176 SN/CP #20	
427	CRAF 178 BN/CP #20	
428	CRAF 178 MBN/CP #20	
429	CRAF 178 SN/CP #20	
430	CRAF 181 AB/CP #20	
431	CRAF 181 MBN/CP #20	
432	CRAF 181 SN/CP #20	
433	CRAF 2014 B AB #50	
434	CRAF 2018 B AB #50	



435	CRAF 2018 C AB #50
436	CRAF 2018 C SN #50
437	CRAF 368 AB/CP #20
438	CRAF 368 BN/CP #20
439	CRAF 368 MBN/CP #20
440	CRAF 368 SN/CP #20
441	CRAF 403 PCF #20
442	CRAF 403 SN #20
443	CRAF 405 AB #20



444	CRAF 405 PCF #20
445	CRAF 405 SB #20
446	CRAF 405 SN #20
447	CRAF 410 B AB #50
448	CRAF 410 B MBN #50
449	CRAF 410 B SN #50
450	CRAF 410 C AB #50
451	CRAF 410 C MBN #50



452	CRAF 410 C SN #50
453	CRAF 413 AB #20
454	CRAF 413 PCF #20
455	CRAF 413 PCF (y3op) #20
456	CRAF 413 SN #20
457	CRAF 413 WW/CP #20
458	CRAF 413 WW/PB #20
459	CRAF 420 PCF #20
460	CRAF 420 SN #20
461	CRAF 423 WW/CP #20



462	CRAF 423 WW/PB #20
463	CRAF 428 AB #20
464	CRAF 428 SB #20
465	CRAF 428 SN #20
466	CRAF 429 AB #20
467	CRAF 429 PCF #20
468	CRAF 429 SB #20
469	CRAF 429 SN #20
470	CRAF 430 AB #20
471	CRAF 430 PCF #20



472	CRAF 430 SB #20
473	CRAF 430 SN #20
474	CRAF 430 WW/CP #20
475	CRAF 430 WW/PB #20
476	CRAF 430 WW/PB (дешевый) #20
477	CRAF 434 AB #20
478	CRAF 434 PCF #20
479	CRAF 434 SN #20
480	CRAF 434 WW/CP #20
481	CRAF 434 WW/PB #20



482	CRAF 438 AB #20	
483	CRAF 438 PCF #20	
484	CRAF 438 SN #20	
485	CRAF 440 AB #20	
486	CRAF 440 SN #20	
487	CRAF 468 AB #20	
488	CRAF 468 PCF #20	
489	CRAF 468 PCF (узор) #20	
490	CRAF 468 WW/CP #20	
491	CRAF 468 WW/CP (дешевый) #20	

492	CRAF 468 WW/PB #20	
493	CRAF 523 AB #20	
494	CRAF 523 MBN/CP #20	
495	CRAF 523 SN #20	
496	CRAF 549 AB #20	
497	CRAF 549 PCF #20	
498	CRAF 549 PCF (узор) #20	
499	CRAF 549 WW/CP #20	
500	CRAF 549 WW/PB #20	
501	CRAF 549 WW/PB (дешевый) #20	

502	CRAF 557 AB/CP #20
503	CRAF 557 BN/CP #20
504	CRAF 557 MBN/CP #20
505	CRAF 557 SN/CP #20
506	CRAF 571 AB #20
507	CRAF 571 PCF #20
508	CRAF 571 SN #20
509	CRAF 571 WWCP #20
510	CRAF 571 WWPB #20
511	CRAF 578 AB #20

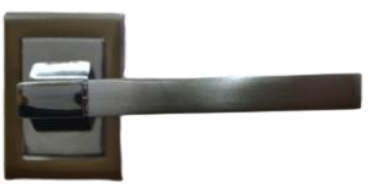



512	CRAF 578 PCF #20	
513	CRAF 578 SB #20	
514	CRAF 578 SN #20	
515	CRAF 578 WW/CP #20	
516	CRAF 578 WW/PB #20	
517	CRAF 578 WW/PB (дешевый) #20	
518	CRAF 580 AB #20	
519	CRAF 580 PCF #20	
520	CRAF 580 PCF (узор) #20	
521	CRAF 580 WW/CP #20	

522	CRAF 580 WW/PB #20
523	CRAF 603 AB/CP #20
524	CRAF 603 BN/CP #20
525	CRAF 603 MBN/CP #20
526	CRAF 603 SN/CP #20
527	CRAF 605 AB/CP #20
528	CRAF 605 MBN/CP #20
529	CRAF 605 SN/CP #20
530	CRAF 606 AB/CP #20
531	CRAF 606 BN/CP #20



532	CRAF 606 SN/CP #20	
533	CRAF 608 AB/CP #20	
534	CRAF 608 BN/CP #20	
535	CRAF 608 MBN/CP #20	
536	CRAF 608 SN/CP #20	
537	CRAF 613 AB/CP #20	
538	CRAF 613 BN/CP #20	
539	CRAF 613 MBN/CP #20	
540	CRAF 613 SN/CP #20	
541	CRAF 701 AB/CP #20	

542	CRAF 701 BN/CP #20	
543	CRAF 701 MBN/CP #20	
544	CRAF 701SN/CP #20	
545	CRAF 702 AB/CP #20	
546	CRAF 702 MBN/CP #20	
547	CRAF 702 SN/CP #20	
548	CRAF 703 SN /CP #20	
549	CRAF 703 AB/CP #20	
550	CRAF 704 AB/CP #20	
551	CRAF 704 MBN/CP #20	

552	CRAF 704 SN/CP #20	
553	CRAF 705 AB/CP #20	
554	CRAF 705 BN/CP #20	
555	CRAF 705 MBN/CP #20	
556	CRAF 705 SN/CP #20	
557	CRAF 707 MBN/CP #20	
558	CRAF 708 AB/CP #20	
559	CRAF 708 MBN/CP #20	
560	CRAF 708 SN/CP #20	
561	CRAF 709 AB/CP #20	

562	CRAF 709 MBN/CP #20	
563	CRAF 709 SN/CP #20	
564	CRAF 801 AB/CP #20	
565	CRAF 801 BN/CP #20	
566	CRAF 801 MBN/CP #20	
567	CRAF 801 SN/CP #20	
568	CRAF 804 AB/CP #20	
569	CRAF 804 BN/CP #20	
570	CRAF 804 MBN/CP #20	
571	CRAF 804 SN/CP #20	

572	CRAF 804 WW/CP #20
573	CRAF 806 AB/CP#20
574	CRAF 806 BN/CP #20
575	CRAF 806 MBN/CP #20
576	CRAF 806 SN/CP#20
577	CRAF 806 WW/CP #20
578	CRAF 808 AB/CP #20
579	CRAF 808 BN/CP#20
580	CRAF 809 AB/CP #20
581	CRAF 809 BN/CP #20

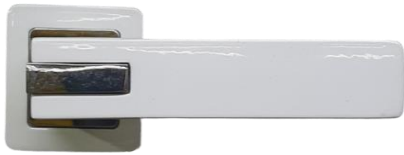

582	CRAF 809 MBN/CP #20	
583	CRAF 809 MSN/CP #20	
584	CRAF 809 SN/CP #20	
585	CRAF 809 WW/CP #20	
586	CRAF 813 AB/CP #20	
587	CRAF 813 BN/CP #20	
588	CRAF 813 MBN/CP #20	
589	CRAF 813 SN #20	
590	CRAF 813 WW/CP #20	
591	CRAF 814 BN/CP #20	



592	CRAF 814 SN #20	
593	CRAF 817 AB/CP #20	
594	CRAF 817 SN/CP #20	
595	CRAF 9171 C AB #50	
596	CRAF 9171 C SN #50	
597	CRAF CX 8550 AB #50	
598	CRAF CX 8550 SN #50	
599	CRAF CX 9050 AB #50	

600	CRAF CX 9050 SN #50	
601	CRAF Сердцевины KD-60 #40	
602	CRAF Сердцевины KD-60 #60	
603	CRAF Сердцевины KD-70 #60	
604	CRAF Сердцевины KD-80 #60	
605	CRAF Сердцевины KD-90 #60	
606	CRAF Сердцевины KW-70 #60	
607	CRAF Сердцевины KW-80 #60	
608	CRAF Сердцевины KW-90 #60	



609	CX 7050 AC Механизм магнитный #50
610	CX 7050 PB Механизм магнитный #50
611	CX 8550 PB Механизм магнитный #50
612	CX 9050 AB Механизм магнитный #50
613	D45 AB #100
614	D45 MBN #100
615	D45 SN #100



616	DRON цветной 40 #240
617	DRON цветной 50 #120
618	DRON цветной 60 #60
619	DRON цветной 70 #48
620	EUSAM висяч з-ки 38мм #240
621	EUSAM висяч з-ки 50мм #120
622	EUSAM висяч з-ки 63мм #60



623	EUSAM висяч з-ки 75мм #60
624	F1 AB\CP (Квадрат) #120
625	F1 BN\CP (Квадрат) #120
626	F1 MBN (Квадрат) #120
627	F1 SN\CP (Квадрат) #120
628	FL1 AB\CP (Квадрат) #120
629	FL1 SN\CP (Квадрат) #120



630	FR1 AB/CP #120
631	FR1 BN/CP #120
632	FR1 MBN/CP #120
633	FR1 SN/CP #120
634	FR1 WW/CP #120
635	FRW1 AB #60
636	FRW1 BN/CP #60



637	FRW1 MBN #60
638	FRW1 SN\CP #60
639	FRW1 WW\CP #60
640	FW1 AB\CP (Квадрат) #60
641	FW1 BN\CP (Квадрат) #60
642	FW1 MBN (Квадрат) #60
643	FW1 SN\CP (Квадрат) #60



644	Jako 20мм+60мм сердц #30
645	KD 60мм Латунь сердц #120
646	KD 70мм Латунь сердц #120
647	KD 80мм Латунь сердц #120
648	KD 90мм Латунь сердц #120
649	KD60 пластик ключ #72
650	KD70 пластик ключ #72
651	KL-02 ручки черные #48
652	KL-03 ручки черные #48





653	KL-04 ручки черные #48
654	KL6123 AB #20
655	KL6123 AC #20
656	KL6129 AB #20
657	KL6223 AC #20
658	KL6235 AB #20
659	KL6235 AC #20



660	KL6235 SN\GP #20
661	KL6346 AB #20
662	KL6346 GOP #20
663	KL6346 PCF #20
664	KL7523 AB #40
665	KL7523 AC #40
666	KL7523 GOP #40



667	KL7523 SN\CP #40
668	KL7535 AB #40
669	KL7535 GOP #40
670	KW 70мм Латунь сердц #120
671	KW 80мм Латунь сердц #120
672	KW 90мм Латунь сердц #120
673	L 1323-80 AB #20
674	L 1323-80 CP #20



675	L 1330-80 AC #20
676	L 1330-80 CP #20
677	L 8524-23 MCF #12
678	L 8524-24 MAB #12
679	L55-273 BRASS #16
680	L55-273 PVD #20
681	L55-284 BRASS #20
682	L55-284 PVD #20
683	L55-367 PCF #16



684	L55-367 WW\CP #20
685	L55-367 WW\GP #20
686	L55-385 BRASS #16
687	L55-385 PVD #16
688	L69-523 AB #16
689	L69-523 BN\CP #16
690	L69-523 SN\CP #16
691	L823-1 AB #24
692	L823-1 AC #24
693	L823-1 PB #24



694	L823-1 SS #24
695	L828-1 AB #24
696	L828-1 AC #24
697	L828-1 PB #24
698	L828-1 SS #24
699	L891-1 AB #24
700	L891-1 AC #24
701	L891-1 PB #24
702	L891-1 SS #24
703	LJ-461 PVD #20



704	LC 55146-1 MAB 600mm Скоба #10	
705	LC 55146-1 MCF 600mm Скоба #10	
706	LC 55146-1 PVD 600mm Скоба #10	
707	LC 55168 24K Скоба #6	
708	LC 55168 MCF Скоба #6	
709	LC 55173 SN\CP Скоба #20	
710	LC 55173 GP Скоба #20	
711	LC 55175 GP Скоба #10	
712	LC 55175 MAB Скоба #10	
713	LC 55192 MAB Скоба #6	

714	LC 55192 ORB Скоба #6
715	LC 5521 MAB 600mm Скоба #20
716	LC 5521 MCF 600mm Скоба #20
717	LC 5521 ORB 600mm Скоба #20
718	LC 5567-1 GP Скоба #20
719	LC 5567-1 MAB Скоба #20
720	LC 5567-1 MCF Скоба #20
721	LC 5572HS GP Скоба #20
722	LC 5572HS MAB Скоба #20
723	LC 5578 24K Скоба #10





724	LC 5578 MAB Скоба #10
725	LC 5582-2 MAB Скоба #10
726	LC 811 GP 600mm Скоба #20
727	LC 811 MAB 600mm Скоба #20
728	LC 811 MCF 600mm Скоба #20
729	LC 812 GP 440mm Скоба #20
730	LC 812 GP 600mm Скоба #20
731	LC 812 MAB 600mm Скоба #20
732	LC 812 MCF 440mm Скоба #20
733	LC 812 MCF 600mm Скоба #20



734	М-1 Пластик ручка легкий #150
735	М-2 Пластик ручка легкий #150
736	М-3 Пластик ручка легкий #150
737	М-4 Пластик ручка легкий #150
738	М-5 Пластик ручка легкий #150
739	MIN 4* 2.5 AC бабочка #50
740	MIN 5*2.5 AB бабочка #50
741	MIN 5*2.5 AC бабочка #50
742	MIN 5*2.5 BN бабочка #50



743	MIN 5*2.5 MCF бабочка #50
744	MIN 5*2.5 SB бабочка #50
745	MIN 5*2.5 SS бабочка #50
746	MIN 5*2.5 WW/PB бабочка #50
747	MIN 5*2.5 WW\CP бабочка #50
748	NORA #20
749	NORA #40
750	ORYAL 70мм Амбарный з_к #48



751	ORYAL 80мм Амбарный з_к #48	
752	ORYAL 90мм Амбарный з_к #48	
753	PALADIUM 755F #50	
754	R1 AB #120	
755	R1 PCF #120	
756	R1 PCF (Узор) #120	
757	R1 PVD #120	

758	R1 SB #120
759	R1 SN #120
760	R1 WW\CP Бежевый #120
761	R1 WW\CP #120
762	R1 WW\PB #120
763	R1 WW\PB Бежевый #120
764	RC-AB EXTRUS #180 (R1 AB)
765	RC-AC EXTRUS #180 (R1 AC)
766	RC-SN/CP EXTRUS #180 (R1 SN)
767	RW1 AB #60









768	RW1 PCF #60
769	RW1 PCF (Узор) #60
770	RW1 PVD #60
771	RW1 SB #60
772	RW1 SN #60
773	RW1 WW\CP #60
774	RW1 WW\CP Бежевый #60



775	RW1 WW\PB #60
776	RW1 WW\PB Бежевый #60
777	S 01 Ручки НЕРЖАВЕЙКИ #20
778	S 02 Ручки НЕРЖАВЕЙКИ #20
779	S 3011-96 AB #30
780	S 3011-96 AC #30
781	S 3011-96 BN\GP #30







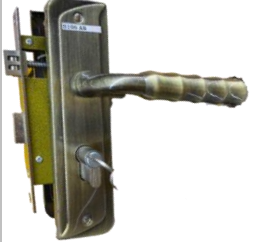

782	S 3011-96 MCF #30	
783	S 3011-96 SN #30	
784	S 3011-96 SN\GP #30	
785	S 3048-07 AB #30	
786	S 3048-07 AC #30	
787	S 3048-07 BN\GP #30	
788	S 3048-07 MCF #30	

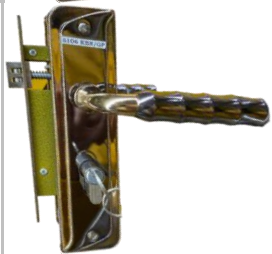

789	S 3048-07 SN #30
790	S 3048-07 SN\GP #30
791	S 3111-23 AB #30
792	S 3111-23 AC #30
793	S 3111-23 MCF #30
794	S 3111-23 SN #30
795	S106 AB #20



796	S106 AC #20	
797	S106 KBN\GP #20	
798	S106 TA\GP #20	
799	S201 AB #20	
800	S201 AC #20	
801	S201 TA\GP #20	
802	S218 AB #20	

803	S218 AC #20
804	S218 KBN\GP #20
805	S218 TA\GP #20
806	S332 AB #20
807	S332 AC #20
808	S332 TA\GP #20
809	S610 AB #20

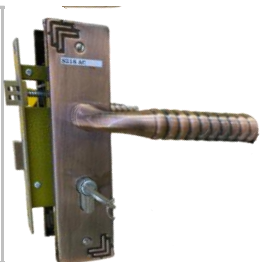

810	S610 KBN\GP #20
811	S610 TA\GP #20
812	S936 AB #20
813	SD 2018 AB #50
814	SD 2018 CP #50
815	SD 410 B-AB #50
816	SD 410 B-CP #50

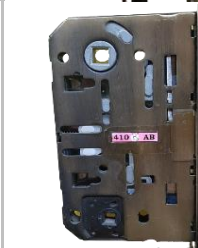

817	SD 410 C-AB #50
818	SD 410 C-CP #50
819	SD 8550 C-AB #50
820	SD 8550 C-CP #50
821	SD 9050 B-AB #50
822	SD 9050 B-CP #50
823	SD 9171 AB #50



824	SD 9171 CP #50
825	SD PE 70-SG AB #50
826	SD PE 70-SG CP #50
827	SF106 AB #20
828	SF106 AC #20
829	SF106 KBN\GP #20
830	SF106 TA\GP #20



831	SF201 AB #20
832	SF201 AC #20
833	SF201 KBNVP #20
834	SF201 SN #20
835	SF201 TA\VP #20
836	SF218 AB #20
837	SF218 AC #20



838	SF218 KBN\GP #20
839	SF218 TA\GP #20
840	SF610 AB #20
841	SF610 AC #20
842	SF610 KBN\GP #20
843	SF610 SN #20
844	SF610 TA\GP #20

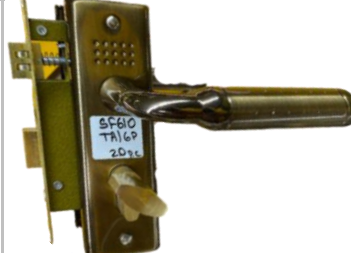
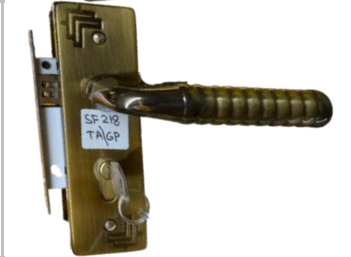



845	SIBA 5001 SN #20
846	SIBA 5005 + Язычек SB #30
847	SIBA 5005 + Язычек SN #30
848	SIBA 6001 SN #20
849	SIBA 6005 AB #20
850	SIBA 6005 AC #20
851	SIBA 6005 SN #20



852	SIBA 8500 AB #20
853	SIBA 8500 AC #20
854	SIBA 8500 KBN\GP #20
855	SIBA 8500 SN #20
856	SIBA 8600 AB #20
857	SIBA 8600 AC #20
858	SIBA 8600 CF #20



859	SIBA 8600 SN #20
860	SOLIE висяч з-ки 30мм #144
861	SOLIE висяч з-ки 40мм #96
862	STIMUL 38мм Вакум #120
863	STIMUL 38мм Вакум Длинный ушка #120
864	STIMUL 50мм Вакум #96
865	STIMUL 63мм Вакум #48



866	STIMUL 75мм Вакум #36
867	STIMUL DZ705 AB #20
868	STIMUL DZ705 PCF #20
869	STIMUL DZ705 SN #20
870	STIMUL DZ723 PCF #20
871	STIMUL DZ723 SN #20
872	STIMUL DZ778 AB #20
873	STIMUL DZ778 PCF #20
874	STIMUL DZ778 SN #20
875	STIMUL F110 BN/CP #20



876	STIMUL F110 SN/CP #20	
877	STIMUL F111 AB #20	
	STIMUL F111 SN/CP #20	
879	STIMUL F132 SN/CP #20	
880	STIMUL F136 AB/CP #20	
881	STIMUL F136 BN/CP #20	
882	STIMUL F136 SN #20	
883	STIMUL F137 BN/CP #20	
884	STIMUL F137 SN/CP #20	
885	STIMUL F138 AB#20	

886	STIMUL F138 BN/CP#20	
887	STIMUL F138 SN/CP #20	
888	STIMUL F152 AB #20	
889	STIMUL F152 BN/CP #20	
890	STIMUL F152 SN/CP #20	
891	STIMUL F153 AB #20	
892	STIMUL F153 SN/CP #20	
893	STIMUL F164 BN #20	
894	STIMUL F164 SN #20	
895	STIMUL F166 BN/CP #20	

896	STIMUL F166 SN/CP #20	
897	STIMUL F173 BN #20	
898	STIMUL F173 SN/CP #20	
899	STIMUL KD-60 Сердцевина #72	
900	STIMUL R23 PCF # 20	
901	STIMUL R23 SN # 20	
902	STIMUL R400 PCF # 20	
903	STIMUL R400 SN # 20	
904	STIMUL R403 PCF #20	
905	STIMUL R403 SN #20	

906	STIMUL R410 AB/CP #20	
907	STIMUL R410 SN/CP #20	
908	STIMUL R413 SN #20	
909	STIMUL R413 WW/CP #20	
910	STIMUL R413 WW/PB #20	
911	STIMUL R420 AB #20	
912	STIMUL R420 PCF # 20	
913	STIMUL R420 SN #20	
914	STIMUL R428 AB # 20	
915	STIMUL R428 SB\CP # 20	



916	STIMUL R428 SN # 20
917	STIMUL R430 PCF # 20
918	STIMUL R430 PVD # 20
919	STIMUL R430 SN #20
920	STIMUL R430 WW\CP # 20
921	STIMUL R434 PCF #20
922	STIMUL R434 SN #20
923	STIMUL R434 WW\CP #20
924	STIMUL R434 WW\PB #20
925	STIMUL R435 AB #20





926	STIMUL R436 WW\CP #20
927	STIMUL R436 WW\PB #20
928	STIMUL R436 AB #20
929	STIMUL R436 PCF #20
930	STIMUL R468 WW\CP #20
931	STIMUL R468 WW\PB #20
932	STIMUL R468 AB #20
933	STIMUL R474 SN # 20
934	STIMUL R474 AB #20
935	STIMUL R474 PCF #20

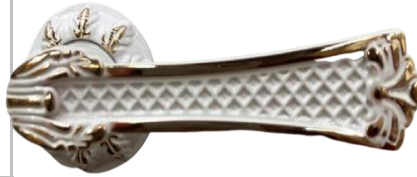

936	STIMUL R478 AB/CP #20
937	STIMUL R478 PCF #20
938	STIMUL R478 WW/CP #20
939	STIMUL R478 WW/PB #20
940	STIMUL R571 AB # 20
941	STIMUL R571 SN # 20
942	STIMUL R577 AC # 20
943	STIMUL R578 WW\CP #20
944	STIMUL R578 WW\PB #20
945	STIMUL R578 AB #20



946	STIMUL R578 PVD #20	
947	STIMUL R578 SN # 20	
948	STIMUL R579 MCF # 20	
949	STIMUL R580 WW\CP #20	
950	STIMUL R580 WW\PB #20	
951	STIMUL R580 AB\CP #20	
952	STIMUL R580 PVD #20	
953	STIMUL Амбарный (XPOM) 70 мм #48	
954	STIMUL Амбарный (XPOM) 80 мм #48	



955	STIMUL Амбарный (ХРОМ) 90 мм #48
956	STIMUL Амбарный жёлтый 70MM #72
957	STIMUL Амбарный жёлтый 80MM #60
958	STIMUL Амбарный жёлтый 90MM #48
959	STIMUL Амбарный красный 70MM #48
960	STIMUL Амбарный красный 80MM #48
961	STIMUL Амбарный красный 90MM #48



962	STIMUL бабочка 4*3 AB #50
963	STIMUL бабочка 4*3 SS #50
964	STIMUL бабочка 4*3 WW/PB #50
965	STIMUL бабочка 4*3 WW/CP #50
966	STIMUL бабочка 5*3 AB #50
967	STIMUL бабочка 5*3 AC #50
968	STIMUL бабочка 5*3 BN/CP #50



969	STIMUL бабочка 5*3 MCF #50
970	STIMUL бабочка 5*3 SB #50
971	STIMUL бабочка 5*3 SS #50
972	STIMUL бабочка 5*3 WW\CP #50
973	STIMUL бабочка 5*3 WW\PB #50
974	STIMUL Механизм 20мм #30
975	STIMUL Механизм 25мм #30



976	STIMUL Механизм 45мм #30
977	STIMUL Механизм 45мм-3м #30
978	STIMUL навесной 38мм #120
979	STIMUL навесной 50мм #72
980	STIMUL навесной 63мм #60
981	STIMUL навесной 75мм #48
982	TF 252 AB #48
983	TF 252 AC #48





984	TF 252 MCF #48	
985	TF 608 MCF #48	
986	TF 608 AB #48	
987	TF 608 AC #48	
988	TF 608 SN/CP #48	
989	TF 701 AB #48	
990	TF 701 AC #48	
991	TF 701 MCF #48	
992	TF 701 SN #48	
993	TL-23 AB #48	
994	TL-23 AC #48	

995	TL-23 SN #48
996	TL-26 AB #48
997	TL-96 AB #48
998	TL-96 AC #48
999	TL-96 BN\GP #48
1000	TL-96 MCF #48
1001	TL-96 SN\CP #48
1002	TL-96 SN\GP #48
1003	TLAN черн 40мм А-5 #120
1004	TLAN черн 50мм А-6 #96



1005	TLAN черн 60мм А-7 #72
1006	TLAN черн 70мм А-8#72
1007	WUZI 60mm #72
1008	WUZI 70mm #48
1009	WUZI 70mm #60
1010	YS-46 T-L MCF #15
1011	YS-46 T-R MCF #15



1012	YUNI 8600 SN\GP # 40
1013	YUNI 8700 SN # 40
1014	YUNI KD100 SS (40+10+50) # 96
1015	YUNI KD100 SS (45+10+45) # 96
1016	YUNI KD68 SB # 96
1017	YUNI KD68 SS # 96
1018	YUNI KD70 SB # 96
1019	YUNI KD70 SS # 96
1020	YUNI KD80 SB (30+10+40) # 96
1021	YUNI KD80 SB (35+10+35) # 96



1022	YUNI KD80 SS (30+10+40) # 96	
1023	YUNI KD80 SS (35+10+35) # 96	
1024	YUNI KD90 SS (35+10+45) # 96	
1025	YUNI KD90 SS (40+10+40) # 96	
1026	YUNI KW100 SS (40+10+50) # 96	
1027	YUNI KW68 SB # 96	
1028	YUNI KW68 SS # 96	
1029	YUNI KW70 SS # 96	
1030	YUNI KW80 SS (30+10+40) # 96	
1031	YUNI KW80 SS (35+10+35) # 96	

1032	YUNI KW90 SS (35+10+45) # 96
1033	YUNI Механизм 25мм #40
1034	YUNI Механизм 45мм-3М #30
1035	Антал 755-2 #50
1036	Бабочка APS 5*2 AB #80
1037	Бабочка APS 5*2 AC #80
1038	Бабочка APS 5*2 SB #80
1039	Бабочка APS 5*2 SS #80

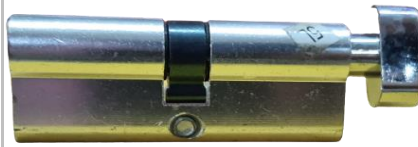

1040	Бабочка ROSSI 4*2 AB #70
1041	Бабочка ROSSI 4*2 SB #70
1042	Бабочка ROSSI 4*2 SS #70
1043	Бабочка ROSSI 5*2.5 AB #70
1044	Бабочка ROSSI 5*2.5 AC #70
1045	Бабочка ROSSI 5*2.5 SB #70
1046	Бабочка ROSSI 5*2.5 SS #70



1047	Бронь--накладки DZ940 сувальдный #96
1048	Бронь--накладки T920С цилиндр #300
1049	Бронь--накладки T923BK сувальдный #300
1050	Бронь--накладки T925BK сувальдный #300
1051	Бронь--накладки T926С цилиндр #300
1052	Бронь--накладки T927BK сувальдный #200
1053	Бронь--накладки T928BK сувальдный #200





1054	Бронь--накладки Т936ВК сувальдный #200
1055	Бронь--накладки Т937С цилиндр #200
1056	Булат 50мм висячие замки #72
1057	Булат 75мм висячие замки #36
1058	ВА3 замок #15
1059	ВА3 сердцевина #120
1060	Велозамок 20-5 #100
1061	Велозамок 20-6 #100

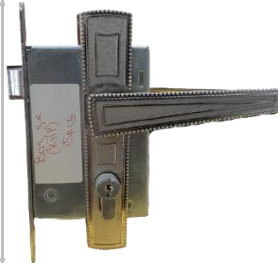

1062	Велозамок 20-8 #60
1063	Велозамок 20-S #120
1064	Велозамок 20-X #100
1065	Велозамок 20-M(кодовый) #100
1066	Велозамок 30-2 #100
1067	Велозамок 30-6 #60
1068	Глазки со шторкой #240
1069	Дверной Молоток #10



1070	Доводчики 051 белый #10
1071	Доводчики 051 коричн #10
1072	Доводчики 051 серебро #10
1073	Доводчики 061 белый #10
1074	Доводчики 061 коричн #10
1075	Доводчики 061 серебро #10
1076	Доводчики 062 белый #10



1077	Доводчики 062 коричн #10
1078	Доводчики 062 серебро #10
1079	Доводчики 065 белый #10
1080	Доводчики 065 коричн #10
1081	Доводчики 065 серебро #10
1082	ЖД замок лев 204-L #12
1083	ЖД замок прав 204-R #12





1084	ЖД РУЧКА лев 204-L #24
1085	ЖД РУЧКА прав 204-R #24
1086	Желтые навесы 38мм #1600
1087	Желтые навесы 50мм #800
1088	Желтые навесы 65мм #800
1089	Желтые навесы 75мм #400
1090	Замок 823 AB L #12



1091	Замок 823 AB R #12
1092	Замок 823 AC L #12
1093	Замок 823 AC R #12
1094	Замок 823 CP L #12
1095	Замок 823 CP R #12
1096	Замок 8523 AB #12
1097	Замок 8523 AC #12



1098	Замок 8523 CP #12	
1099	Замок 8596 AB #12	
1100	Замок 8596 AC #12	
1101	Замок 8596 CP #12	
1102	Зубер 55*156F #60	
1103	Зубер 56*189-4 #30	
1104	Зубер 57*855-2 3 кл #30	

1105	Зубер 800 #60	
1106	Зубер бабочка 4*2.5 АВ #50	
1107	Зубер бабочка 4*2.5 АС #50	
1108	Зубер бабочка 4*2.5 ВNCP #50	
1109	Зубер бабочка 4*2.5MCF #50	
1110	Зубер бабочка 4*2.5SS #50	
1111	Зубер бабочка 5*3 АС #50	



1112	Зубер бабочка 5*3 BN/CP #50
1113	Зубер бабочка 5*3 SB #50
1114	Зубер хром сердц KW60 #120
1115	Зубер хром сердц KW70 #120
1116	Зубер хром сердц KW70 AB #120
1117	Зубер хром сердц KW80 #120
1118	Зубер хром сердц KW90 #120



1119	Зубер хром сердц KD60 #120
1120	Зубер хром сердц KD70 #120
1121	Зубер хром сердц KD70 АВ #120
1122	Зубер хром сердц KD80 #120
1123	Зубер хром сердц KD90 #120
1124	КНР АМБАРНЫЙ 70ММ #40
1125	КНР АМБАРНЫЙ 80ММ #40



1126	КНР АМБАРНЫЙ 90ММ #20
1127	Ковбой навесы 4 #40
1128	Ковбой навесы 5 #30
1129	Ковбой навесы 6 #20
1130	Кодовый замок #18
1131	КРАСНОЕ Дерево ручка #24
1132	КРАСНОЕ Дерево ручка Граненый #24

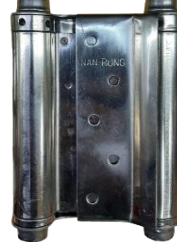

1133	Мебельная пуговка пластик 22 №1 #1000
1134	Мебельная пуговка пластик 23 №2 #1000
1135	Мебельная пуговка пластик 24 №3 #1000
1136	Мебельная пуговка пластик 28 №4 #1000
1137	Мебельная пуговка пластик 38 №5 #1000
1138	Мебельная пуговка пластик 39 №6 #1000
1139	Мебельная пуговка пластик 43 №7 #1000



1140	Мебельная пуговка пластик 61 №8 #1000
1141	Мебельная пуговка пластик 69 №9 #1000
1142	Мебельные замки 101 #240
1143	Мебельные замки 138 #240
1144	Мебельные замки 139 #240
1145	Мебельные замки 338 #240
1146	Мебельные Ручки 1020- 28 #1000

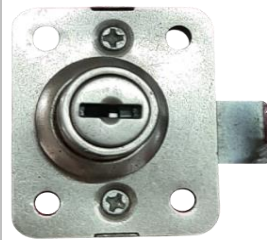

1147	Мебельные Ручки 1020- АВ #1000
1148	Мебельные Ручки 1021- 22 #1000
1149	Мебельные Ручки 1021- 28 #1000
1150	Мебельные Ручки 1021- 61 #1000
1151	Мебельные Ручки 1021- GP #1000
1152	Мебельные Ручки 1028- АВ #1000
1153	Мебельные Ручки 1028- CP #1000



1154	Мебельные Ручки 1028- GP #1000
1155	Мебельные Ручки 1029- AB #1000
1156	Мебельные Ручки 1029- CP #1000
1157	Мебельные Ручки 1029- GP #1000
1158	Мебельные Ручки 1503- AB #1000
1159	Механизм 20мм + Сердцевина 70мм #30
1160	Механизм 252 (888-сувальн) #20



1161	Механизм 25мм #50
1162	Механизм 35мм #30
1163	Механизм 35мм (на пластик) #50
1164	Механизм 40мм #30
1165	Механизм 45мм #30
1166	Механизм 45мм - 3м #30
1167	Механизм 556 #20







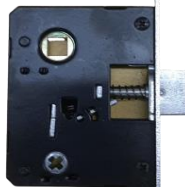







1168	Механизм 60мм #30
1169	Механизм 858 L #20
1170	Механизм 858 R #20
1171	Механизм 9036 SN #50
1172	Механизм ВК #100
1173	Механизм кругл #40
1174	Механизм кругл дорогой #25



1175	Механизм на Нерж 1739 #24	
1176	Механизм плоский #48	
1177	МОККО Дерево ручка#24	
1178	Накладной замок 603 #30	
1179	Накладной замок 604 #30	
1180	Накладной замок DAF 540-120 #24	
1181	Накладной замок DAF 540-120 (Новый) #30	
1182	Накладной замок DAF 540-120 Ригель #24	
1183	Накладной замок DAF 540-140 #30	





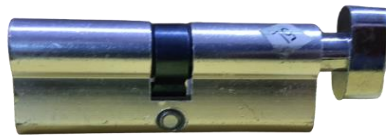





1184	Накладной замок DAF 540-140 3-Ригель #30	
1185	нестандарт KD68 5кл KGP (узор) #120	
1186	нестандарт KD68 5кл MCF (узор) #120	
1187	нестандарт KD68 5кл #120	
1188	нестандарт KW68 5кл #120	
1189	нестандарт KW68 5кл KGP (узор) #120	
1190	нестандарт KW68 5кл MCF (узор) #120	
1191	Нестандарт сердц (ДОРОГ) KW68 3кл #120	
1192	Нестандарт сердц KD68 SS 3кл #120	
1193	Нестандарт сердц KW68 3кл #120	
1194	Нестандарт сердц (дешевый) KW68 SS #150	

1195	Нестандарт сердц (дешевый) KW68 SS #200
1196	НЛО замок #20
1197	Оконная завертка АС #240
1198	Оконная завертка GP #240
1199	Почтовый мебельн замок 103-25 #240
1200	Почтовый мебельн замок 103-16 #240
1201	Резиновый Корпус 45мм 4кл замки #120
1202	Резиновый Корпус 45мм Длинные замки #120
1203	Резиновый Корпус 55мм замки #96



1204	Резиновый Корпус 65мм замки #72
1205	Резиновый Корпус 75мм замки #72
1206	СХ-03 Магнитный ЯЗЫЧОК АВ #100
1207	СХ-03 Магнитный ЯЗЫЧОК SN #100
1208	сварочные навесы 110 #80
1209	сварочные навесы 130 #50
1210	сварочные навесы 140*20 #50
1211	сварочные навесы 150 #50
1212	Сердцевина смещен ВАКУМ 100 #90



1213	Сердцевина смещен ВАКУМ 75 #90	
1214	Сердцевина смещен ВАКУМ 80 #90	
1215	Сердцевина смещен ВАКУМ 90 #90	
1216	Сердцевина смещен ВАКУМ 95 #90	
1217	Сердцевина смещен (AL) 75#100	
1218	Сердцевина смещен (AL) 70#100	
1219	Сердцевина смещен (AL) 80#100	
1220	Сердцевина смещен (AL) 85#100	
1221	Сердцевина смещен (AL) 90#100	
1222	Сердцевина смещен 100 #100	

1223	Сердцевина смещен 70#100
1224	Сердцевина смещен 75#100
1225	Сердцевина смещен 80#100
1226	Сердцевина смещен 85#100
1227	Сердцевина смещен 90#100
1228	Сердцевина смещен 95#100
1229	Сердцевина упаковка KD-60 #80
1230	Сердцевина упаковка KD-70 #80
1231	Сердцевина упаковка KD-80 #80
1232	Сердцевина упаковка KD-90 #80



1233	Сердцевина упаковка KW-70 #80	
1234	Сердцевина упаковка KW-80 #80	
1235	Сердцевина упаковка KW-90 #80	
1236	СЕРЫЙ Амбарный 70MM #48	
1237	СЕРЫЙ Амбарный 80MM #48	
1238	СЕРЫЙ Амбарный 90MM #48	
1239	Серый навесной з-к < A > #24	
1240	Серый навесной з-к < O > #24	
1241	Серый навесной з-к < B > #48	



1242	стопр M71 L AB #240
1243	стопр M71 L AC #240
1244	стопр M71 L PB #240
1245	стопр M71 L SS #240
1246	стопр M71 M AB #360
1247	стопр M71 M AC #360
1248	стопр M71 M PB #360



1249	стопр M71 M SS #360
1250	стопр магнитный 622 MCF #160
1251	стопр магнитный 853 A PB #160
1252	Стопр 009 AB #360
1253	Стопр 009 AC #360
1254	Стопр 009 PB #360
1255	Стопр 009 SS #360



1256	Стопр 415 АВ #120
1257	Стопр 552 АВ #360
1258	Стопр 552 АС #360
1259	Стопр 552 ВВ #360
1260	Стопр 552 SS #360
1261	Стопр 819 АВ #200
1262	Стопр 819 ВN #200
1263	Стопр mod-2 АВ #240



1264	Стопр mod-2 AC #240
1265	Стопр mod-2 PB #120
1266	Стопр mod-4 AB #300
1267	Стопр mod-4 AC #300
1268	Стопр mod-4 AB #120
1269	Стопр mod-4 PB #120
1270	Стопр mod-4 PB #300



1271	Стопр mod-4 SN #300
1272	Стопр магнитный 305 BN #160
1273	Стопр магнитный 305 MCF #160
1274	Стопр магнитный 305 SB #160
1275	Стопр магнитный 410 АВ #120
1276	Стопр магнитный 417 АВ #120
1277	Стопр магнитный 417 MCF #120

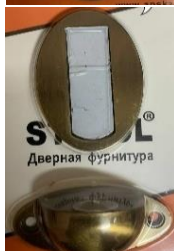

1278	Стопр магнитный 506 АВ #160
1279	Стопр магнитный 506 АС #160
1280	Стопр магнитный 506 МСF #160
1281	стопр магнитный 525 ВN #240
1282	стопр магнитный 525 МСF #120
1283	Фурор YS-09 ВN #20
1284	Фурор YS-09 МСF #20



1285	ЦВЕТНОЙ 65 мм длин #72
1286	Цепочка на дверь АВ #200
1287	Цепочка на дверь АС #200
1288	Чаз большой #40
1289	Чаз квадрат #40
1290	Чаз длинный #40
1291	Чаз мал ушка #40
1292	ЧЕРЕПАХА КНР 80ММ #20



1293	ЧЕРЕПАХА КНР 90ММ #20
1294	Шарик АС # 540
1295	Шарик СР # 540
1296	Шарик РВ # 540
1297	шарик М18 АВ шарик #240
1298	шарик М18 АС шарик #240
1299	шарик М18 МСF шарик #240





1300	шарик М18 РВ шарик #240
1301	шарик М18 РВ шарик #300
1302	шарик М18 СР шарик #240
1303	Шпингалет 2204 АС апекс #320
1304	Шпингалет 2204 РВ апекс #320
1305	Шпингалет 555-100 #144
1306	Шпингалет 555-120 #120
1307	Шпингалет 555-150 #60
1308	Шпингалет 777-100 #72



1309	Шпингалет 777-120 #72
1310	Шпингалет 777-140 #48
1311	ЭКСТРА (ВАКУМ) SOL 70мм #72
1312	ЭКСТРА (ВАКУМ) SOL 60мм #72
1313	ЭКСТРА (ВАКУМ) SOL Длин Ушка 40мм #120
1314	ЭКСТРА 30мм #240
1315	ЭКСТРА 40мм #180
1316	Экстра 50мм #120



1317	Экстра 60мм #120
1318	Экстра 70мм #72
1319	Экстра 80мм #48
1320	Экстра 90мм #36
1321	ЯЗЫЧОК L45 AB #100
1322	ЯЗЫЧОК L45AC #100
1323	ЯЗЫЧОК L45PB #100
1324	ЯЗЫЧОК L45SN #100

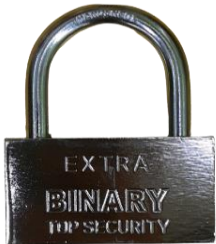
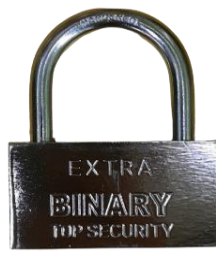

1325	ЯЗЫЧОК дешевый #100
1326	
1327	
1328	
1329	
1330	
1331	
1332	
1333	
1334	
1335	
1336	
1337	
1338	
1339	
1340	
1341	
1342	
1343	
1344	
1345	
1346	
1347	
1348	
1349	
1350	
1351	
1352	
1353	
1354	
1355	
1356	
1357	
1358	
1359	
1360	
1361	
1362	
1363	
1364	
1365	
1366	
1367	
1368	
1369	
1370	

1371
1372
1373
1374
1375
1376
1377
1378
1379
1380
1381
1382
1383
1384
1385
1386
1387
1388
1389
1390
1391
1392
1393
1394
1395
1396
1397
1398
1399
1400
1401
1402
1403
1404
1405
1406
1407
1408
1409
1410
1411
1412
1413
1414
1415
1416
1417
1418
1419
1420

1421
1422
1423
1424
1425
1426
1427
1428
1429
1430
1431
1432
1433
1434
1435
1436
1437
1438
1439
1440
1441
1442
1443
1444
1445
1446
1447
1448
1449
1450
1451
1452
1453
1454
1455
1456
1457
1458
1459
1460
1461
1462
1463
1464
1465
1466
1467
1468
1469
1470

1471
1472
1473
1474
1475
1476
1477
1478
1479
1480
1481
1482
1483
1484
1485
1486
1487
1488
1489
1490
1491
1492
1493
1494
1495
1496
1497
1498
1499
1500
1501
1502
1503
1504
1505
1506
1507
1508
1509
1510
1511
1512
1513
1514
1515
1516
1517
1518
1519
1520

1521
1522
1523
1524
1525
1526
1527
1528
1529
1530
1531
1532
1533
1534
1535
1536
1537
1538
1539
1540
1541
1542
1543
1544
1545
1546
1547
1548
1549
1550
1551
1552
1553
1554
1555
1556
1557
1558
1559
1560
1561
1562
1563
1564
1565
1566
1567
1568
1569
1570



1571
1572
1573
1574
1575
1576
1577
1578
1579
1580
1581
1582
1583
1584
1585
1586
1587
1588
1589
1590
1591
1592
1593
1594
1595
1596
1597
1598
1599
1600
1601
1602
1603
1604
1605
1606
1607
1608
1609
1610
1611
1612
1613
1614
1615
1616
1617
1618
1619
1620

1621
1622
1623
1624
1625
1626
1627
1628
1629
1630
1631
1632
1633
1634
1635
1636
1637
1638
1639
1640
1641
1642
1643
1644
1645
1646
1647
1648
1649
1650
1651
1652
1653
1654
1655
1656
1657
1658
1659
1660
1661
1662
1663
1664
1665
1666
1667
1668
1669
1670

1671
1672
1673
1674
1675
1676
1677
1678
1679
1680
1681
1682
1683
1684
1685
1686
1687
1688
1689
1690
1691
1692
1693
1694
1695
1696
1697
1698
1699
1700
1701
1702
1703
1704
1705
1706
1707
1708
1709
1710
1711
1712
1713
1714
1715
1716
1717
1718
1719
1720

1721
1722
1723
1724
1725
1726
1727
1728
1729
1730
1731
1732
1733
1734
1735
1736
1737
1738
1739
1740
1741
1742
1743
1744
1745
1746
1747
1748
1749
1750
1751
1752
1753
1754
1755
1756
1757
1758
1759
1760
1761
1762
1763
1764
1765
1766
1767
1768
1769
1770

1771
1772
1773
1774
1775
1776
1777
1778
1779
1780
1781
1782
1783
1784
1785
1786
1787
1788
1789
1790
1791
1792
1793
1794
1795
1796
1797
1798
1799
1800
1801
1802
1803
1804
1805
1806
1807
1808
1809
1810
1811
1812
1813
1814
1815
1816
1817
1818
1819
1820

1821
1822
1823
1824
1825
1826
1827
1828
1829
1830
1831
1832
1833
1834
1835
1836
1837
1838
1839
1840
1841
1842
1843
1844
1845
1846
1847
1848
1849
1850
1851
1852
1853
1854
1855
1856
1857
1858
1859
1860
1861
1862
1863
1864
1865
1866
1867
1868
1869
1870

1871
1872
1873
1874
1875
1876
1877
1878
1879
1880
1881
1882
1883
1884
1885
1886
1887
1888
1889
1890
1891
1892
1893
1894
1895
1896
1897
1898
1899
1900
1901
1902
1903
1904
1905
1906
1907
1908
1909
1910
1911
1912
1913
1914
1915
1916
1917
1918
1919
1920

1921
1922
1923
1924
1925
1926
1927
1928
1929
1930
1931
1932
1933
1934
1935
1936
1937
1938
1939
1940
1941
1942
1943
1944
1945
1946
1947
1948
1949
1950
1951
1952
1953
1954
1955
1956
1957
1958
1959
1960
1961
1962
1963
1964
1965
1966
1967
1968
1969
1970



1971
1972
1973
1974
1975
1976
1977
1978
1979
1980
1981
1982
1983
1984
1985
1986
1987
1988
1989
1990
1991
1992
1993
1994
1995
1996
1997
1998
1999
2000
2001
2002
2003
2004
2005
2006
2007
2008
2009
2010
2011
2012
2013
2014
2015
2016
2017
2018
2019
2020

2021
2022
2023
2024
2025
2026
2027
2028
2029
2030
2031
2032
2033
2034
2035
2036
2037
2038
2039
2040
2041
2042
2043
2044
2045
2046
2047
2048
2049
2050
2051
2052
2053
2054
2055
2056
2057
2058
2059
2060
2061
2062
2063
2064
2065
2066
2067
2068
2069
2070

2071
2072
2073
2074
2075
2076
2077
2078
2079
2080
2081
2082
2083
2084
2085
2086
2087
2088
2089
2090
2091
2092
2093
2094
2095
2096
2097
2098
2099
2100
2101
2102
2103
2104
2105
2106
2107
2108
2109
2110
2111
2112
2113
2114
2115
2116
2117
2118
2119
2120

2121
2122
2123
2124
2125
2126
2127
2128
2129
2130
2131
2132
2133
2134
2135
2136
2137
2138
2139
2140
2141
2142
2143
2144
2145
2146
2147
2148
2149
2150
2151
2152
2153
2154
2155
2156
2157
2158
2159
2160
2161
2162
2163
2164
2165
2166
2167
2168
2169
2170

2171
2172
2173
2174
2175
2176
2177
2178
2179
2180
2181
2182
2183
2184
2185
2186
2187
2188
2189
2190
2191
2192
2193
2194
2195
2196
2197
2198
2199
2200
2201
2202
2203
2204
2205
2206
2207
2208
2209
2210
2211
2212
2213
2214
2215
2216
2217
2218
2219
2220

2221
2222
2223
2224
2225
2226
2227
2228
2229
2230
2231
2232
2233
2234
2235
2236
2237
2238
2239
2240
2241
2242
2243
2244
2245
2246
2247
2248
2249
2250
2251
2252
2253
2254
2255
2256
2257
2258
2259
2260
2261
2262
2263
2264
2265
2266
2267
2268
2269
2270

2271
2272
2273
2274
2275
2276
2277
2278
2279
2280
2281
2282
2283
2284
2285
2286
2287
2288
2289
2290
2291
2292
2293
2294
2295
2296
2297
2298
2299
2300
2301
2302
2303
2304
2305
2306
2307
2308
2309
2310
2311
2312
2313
2314
2315
2316
2317
2318
2319
2320

2321
2322
2323
2324
2325
2326
2327
2328
2329
2330
2331
2332
2333
2334
2335
2336
2337
2338
2339
2340
2341
2342
2343
2344
2345
2346
2347
2348
2349
2350
2351
2352
2353
2354
2355
2356
2357
2358
2359
2360
2361
2362
2363
2364
2365
2366
2367
2368
2369
2370



2371
2372
2373
2374
2375
2376
2377
2378
2379
2380
2381
2382
2383
2384
2385
2386
2387
2388
2389
2390
2391
2392
2393
2394
2395
2396
2397
2398
2399
2400
2401
2402
2403
2404
2405
2406
2407
2408
2409
2410
2411
2412
2413
2414
2415
2416
2417
2418
2419
2420

2421
2422
2423
2424
2425
2426
2427
2428
2429
2430
2431
2432
2433
2434
2435
2436
2437
2438
2439
2440
2441
2442
2443
2444
2445
2446
2447
2448
2449
2450
2451
2452
2453
2454
2455
2456
2457
2458
2459
2460
2461
2462
2463
2464
2465
2466
2467
2468
2469
2470

2471
2472
2473
2474
2475
2476
2477
2478
2479
2480
2481
2482
2483
2484
2485
2486
2487
2488
2489
2490
2491
2492
2493
2494
2495
2496
2497
2498
2499
2500
2501
2502
2503
2504
2505
2506
2507
2508







































































